

INSTALLATION:

THE E-STYLE DISCONNECT MATES WITH ANY OF OUR E-STYLE CORDS. APPLY 24 VDC TO THE BROWN AND BLUE LEADS, POLARITY IS UNIMPORTANT. BLACK IS AN INDEPENDENT GROUND. WHITE IS NULL.

MAINTENANCE INSTRUCTIONS:

ELECTROMAGNETS REQUIRE VERY LITTLE MAINTENANCE TO PROVIDE A LONG USEFUL LIFE. DAILY USE OF A SHOP TOWEL TO WIPE THE FACE OF THE MAGNET FREE OF DEBRIS, GREASE AND OIL OR OTHER FOREIGN MATTER WILL ENSURE YEARS OF SERVICE LIFE AND THOUSANDS OF SAFE LIFTS.

MODEL: BPV-20060E-24C
VOLTAGE: 24VDC
POWER: 36 WATTS
DUTY CYCLE: CONTINUOUS
HOLDING POWER: 372 LBS

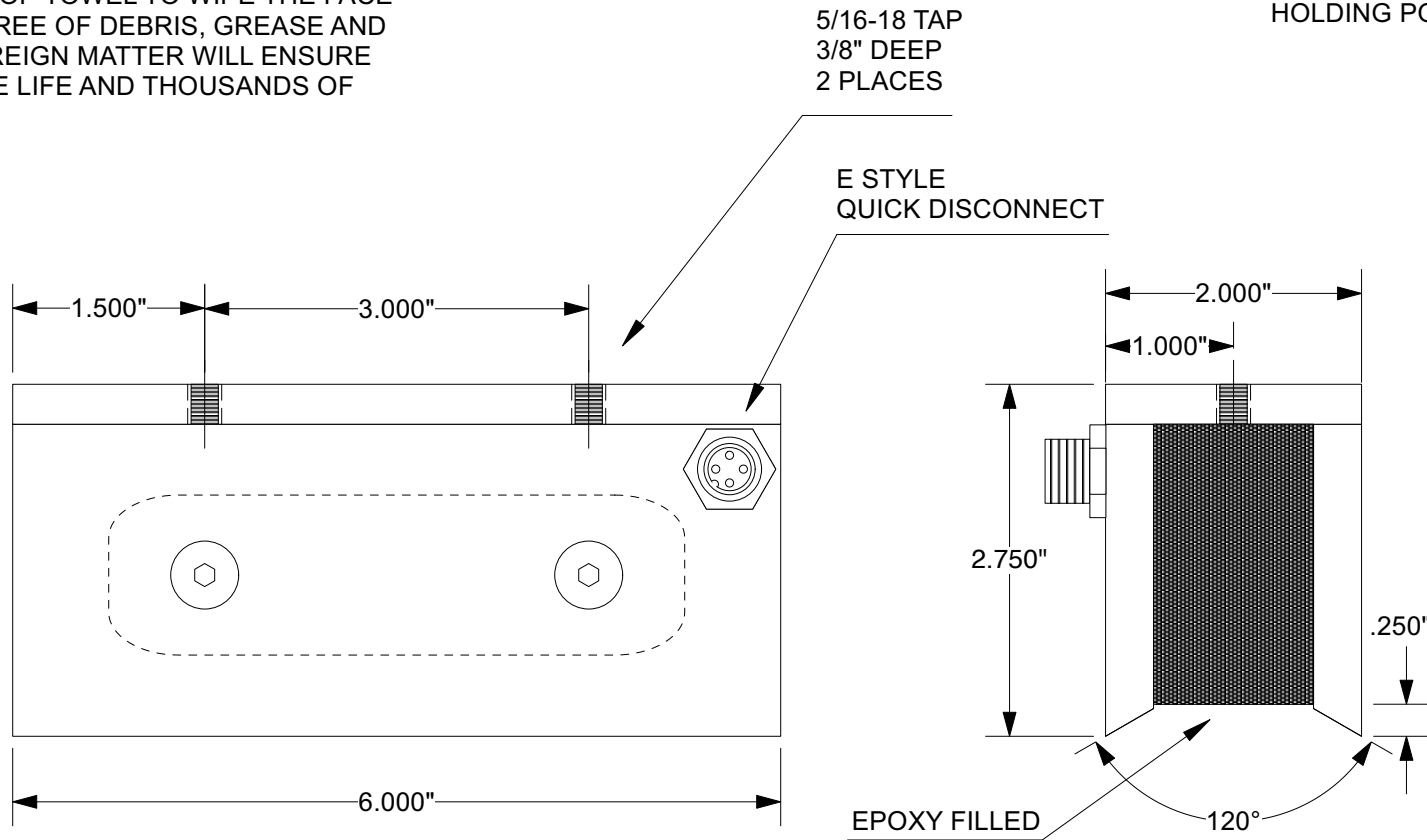

IF YOU HAVE ANY QUESTIONS ABOUT THIS MAGNET OR THE CORRESPONDING DC POWER SUPPLY, PLEASE CALL OUR ENGINEERING DEPARTMENT FOR ASSISTANCE: (1-800-635-3954)

AUTOMATIC EQUIPMENT CORP
BPV-20060E-24C
CUST DWG
05/19/22
H-15550